

English Sentence Structure and Entity-Relationship Diagrams

PETER PIN-SHAN CHEN*

Graduate School of Management, University of California, Los Angeles, California 90024

ABSTRACT

In many information system projects, information requirements are initially documented in English, and then database designers convert these English descriptions into database schemas in terms of entity-relationship (ER) diagrams (or other similar representations). This paper studies the correspondence between English sentence structure and ER diagrams, and proposes eleven rules for translation. The basic constructs of English, such as noun, verb, adjective, adverb, gerund, and clause, are found to have counterparts in the ER diagrammatic technique. Finally, an example is used to demonstrate the applicability of these rules in database design.

1. INTRODUCTION

The entity-relationship (ER) diagrammatic technique [4] is a graphic way of displaying entity types, relationship types, and attributes. Many people have found the technique useful for modeling user information requirements. One of the reasons often cited is that the ER diagram is easy to understand not only for systems analysts and database designers but also for managers and users. Therefore, the ER diagram can serve as a good communication tool between the systems people and the users during the process of identifying user information requirements.

In order to construct a database using the ER diagram, the database designer not only has to interview users but also must study the documentation of the old system (if there is one) and the functional specifications of the new system. Since most of this documentation or specification material is in English (or other natural languages), it is difficult to decipher the contents of these documents into database schemas as defined by ER diagrams. There is a critical need for devising rules or guidelines for converting English descriptions into ER diagrams. This motivates our research into the correspondence between English sentence structure and entity-relationship diagrams.

*Author's current address: Department of Computer Science, Louisiana State University, Baton Rouge, LA 70803.

The ER diagram was formally proposed in [4]. Figure 1(a) is an example of a simple ER diagram. The rectangular-shaped boxes represent entity types, and the diamond-shaped boxes represent relationship types. For example, in Figure 1(a), "EMP" (EMPLOYEE) and "PROJ" (PROJECT) are entity types, and "WORKS-FOR" is a relationship type. The "M" and "N" in the diagram indicate that the relationship "WORKS-FOR" is many-to-many. In other words, an employee may work for several projects, and a project may have several employees. For those relationships which are one-to-one or one-to-many, we will indicate that property accordingly in the ER diagrams. Figure 1(a) displays only entity and relationship types.

In certain situations, we need to display the properties of entities and relationships in terms of attributes and value types. Figure 1(b) is an example of an ER diagram with attributes and value types. The value types are represented by circles, and the attributes are represented by the lines connecting the entity and relationship types to the circles. In Figure 1(b), EMP#, EMP-NAME, and AGE are attributes of EMPLOYEE entities. NUMBER, NAME, and NUMBER-OF-YEARS are the corresponding value types for these attributes. Relationships may have

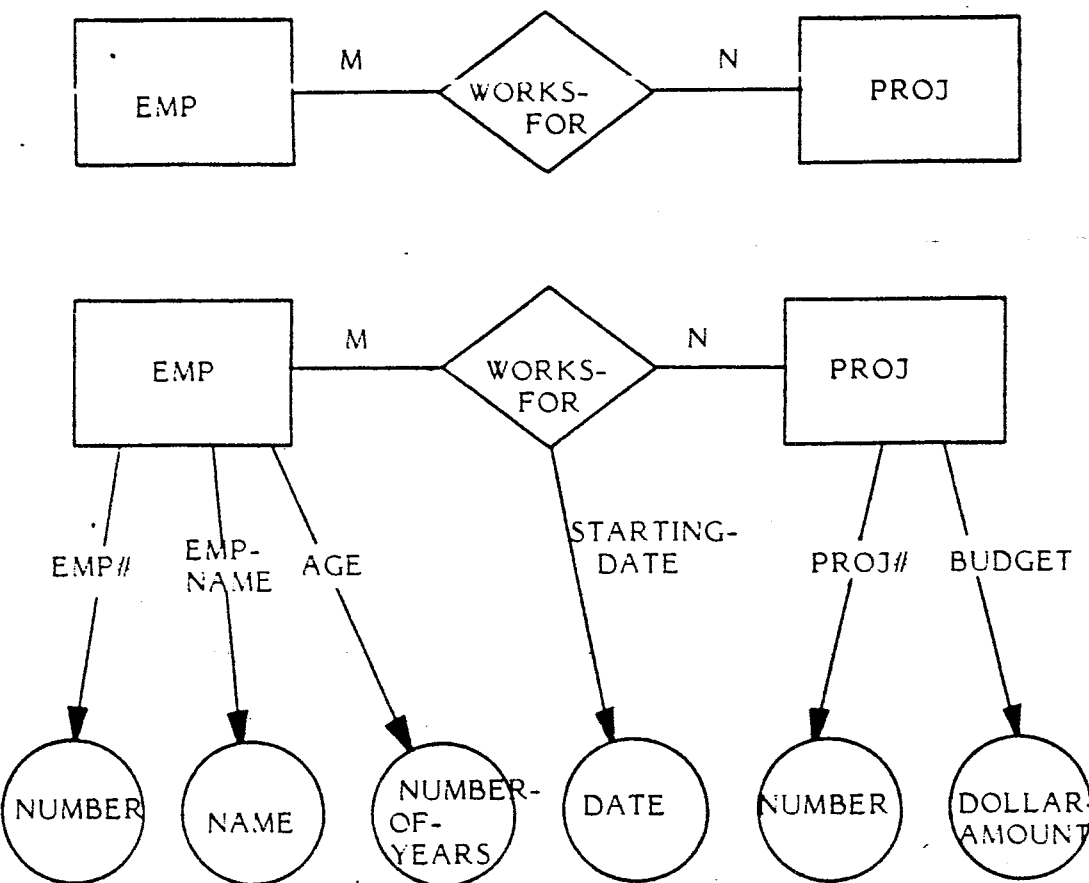

Fig. 1. An entity-relationship (ER) diagram: (a) without attributes and value types, (b) with attributes and value types.

attributes, too. For example, **STARTING-DATE** is an attribute of a "WORKS-FOR" relationship, since it describes the starting date of a particular employee on a particular project.

The above is a short introduction to ER diagrams. The reader may refer to [5, 7-9, 11-13, 17] for more detailed discussions of the ER diagrammatic technique and its applications.

There are many variations of ER diagrams proposed by different people or used by different organizations. Figure 2 illustrates several versions of ER diagrams. The last version in Figure 2 is the version being considered as a possible standard by the International Standards Organization (ISO). A detailed discussion of different forms of ER diagrams and models can be found in [6]. For the purpose of this paper, we will use the version illustrated in Figure 1(a) and (b). Readers may extend the ideas discussed in this paper to the version of the ER diagram they prefer to use.

After the formal introduction in 1976, there have been many proposals to extend the ER diagrammatic technique. For example, Lee and Gerritsen [10] propose a technique for modeling the fact that an entity type is a subset of

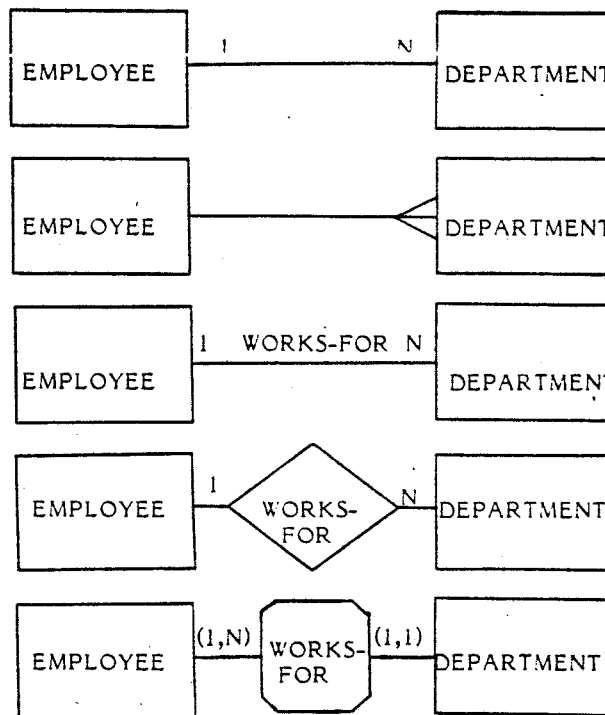

Fig. 2. Different forms of entity-relationship (ER) diagrams.

another entity type and that an entity type can be decomposed into several entity types by the range of values of a particular attribute. Schiffner and Scheuermann [15] introduce the abstracting capabilities of the ER diagram: it allows the abstraction of a group of low-level interlinked entity and relationship types into a high-level entity type. Santos, Neuhold, and Furtado [14] propose to use algebraic operators (such as the Cartesian product) to form new entity types. Batini [1] proposes a set of rules for the decomposition of ER diagrams: starting with only one entity type in the diagram, a comprehensive ER diagram can be derived by systematically applying the decomposition rules. Webre [18] proposes many different variations of relationship types. There are many other extensions which we do not have room to discuss here. The purpose of this paper is to consolidate their proposals, to develop further the ER diagrammatic technique, and, more importantly, to relate the ER diagrammatic technique to English sentence structure.

The rest of the paper is divided into three sections. Section 2 describes the rules for translating English statements into ER diagrams. Section 3 describes an example of using these rules in translating an English description of information requirements into an ER diagram. Section 4 is the conclusion.

2. TRANSLATION RULES

What we intend to do here is to classify certain patterns of English usage and to identify the counterpart components in ER diagrams. In this section, we will present eleven rules for translating English sentences into ER diagrams. Although we call them "rules," they might better be viewed as "guidelines," since it is possible to find counterexamples to them. The following are the detailed explanations of the translation rules:

RULE 1. A *common noun* (such as "person," "chair") in English corresponds to an *entity type* in an ER diagram.

RULE 2. A *transitive verb* in English corresponds to a *relationship type* in an ER diagram.

EXAMPLE A.

English statement: A person may own a car and may belong to a political party.

Analysis: Note that "person," "car," and "political party" are nouns and therefore correspond to entity types. Note also that "own" and "belong to" are transitive verbs (or verb phrases) and therefore correspond to relationship types.

ER diagram: The corresponding ER diagram is shown in Figure 3.

RULE 3. An *adjective* in English corresponds to an *attribute of an entity* in an ER diagram.

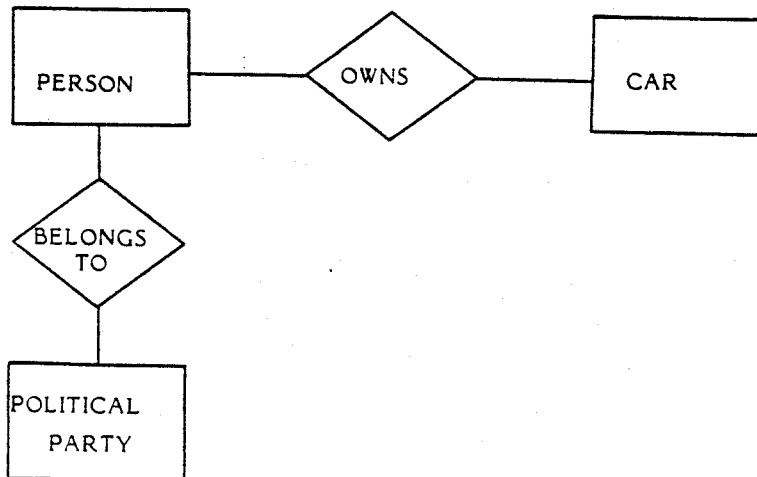

Fig. 3. An ER diagram for Example A.

RULE 4. An *adverb* in English corresponds to an *attribute of a relationship* in an ER diagram.

EXAMPLE B.

English statement: A 40-year-old person works on a project with project number 2175 for 20% of his time.

Analysis: "Person" and "project" are nouns and can be considered as entity types. Since "40-year-old" is an "adjective" modifying the noun "person", we can consider "number of years old" (or "age") as an attribute of person entities. Similarly, since "with Project number 2175" is an adjective phrase modifying the noun "project," we can view "project number" as an attribute of "project" entities. "Works on" is a transitive verb phrase and therefore corresponds to a relationship type. Since "for 20% of his time" is an adverb phrase used to modify the verb phrase "works on," we can consider "percentage of time" as an attribute of "works on" relationships.

ER diagram: The corresponding ER diagram is shown in Figure 4.

RULE 5. If the sentence has the form: "There are ... X in Y," we can convert it into the equivalent form "Y has ... X."

EXPLANATION. Since we are interested in the semantics of each sentence, we may use an equivalent form of the sentence in order to derive the corresponding ER diagram. In its deep semantics the sentence "there are ... X in Y" is equivalent to the sentence "Y has ... X," which can be easily translated into an ER diagram.

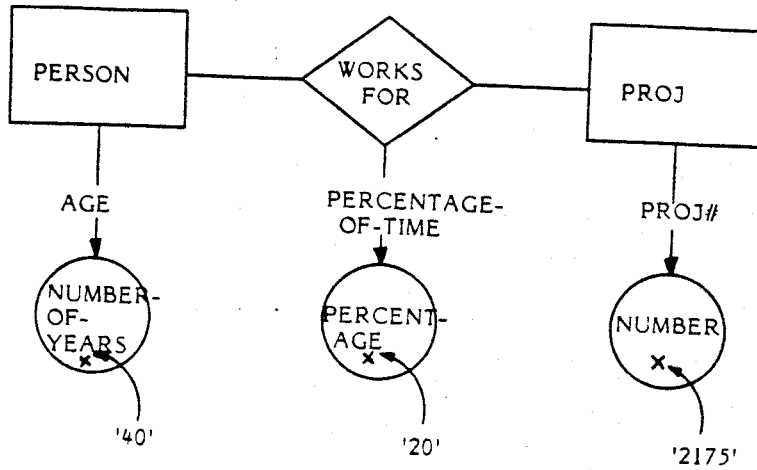

Fig. 4. An ER diagram for Example B.

EXAMPLE C.

English statement: There are 200 employees in this department.

Analysis: The equivalent form of the sentence is: "The department has 200 employees."

ER diagram: The corresponding ER diagram is shown in Figure 5.

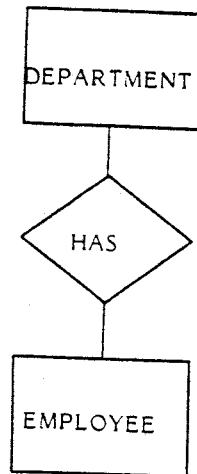

Fig. 5. An ER diagram for Example C.

RULE 6. If the English sentence has the form "The X of Y is Z " and if Z is a *proper noun*, we may treat X as a *relationship* between Y and Z . In this case, both Y and Z represent entities.

RULE 7. If the English sentence has the form "The X of Y is Z " and if Z is not a *proper noun*, we may treat X as an *attribute* of Y . In this case, Y represents an *entity* (or a group of entities), and Z represents a *value*.

EXPLANATION. When the sentence pattern is "The X of Y is Z ," we may say Y represent an entity (or a group of entities). However, we do not know whether Z represent an entity or not, and neither do we know whether X represent a relationship or not. What we can say is that there is some kind of association between Y and Z , but we cannot tell whether this association is one of relationship or attribute. It seems that whether X is an attribute or relationship depends primarily on what Z represents. If Z is a proper noun (such as "John Kennedy," "The United Kingdom"), then Z implicitly refers to an entity although Z itself is considered as a value of a certain value type. For example, "John Kennedy" could refer to a "person" entity, although "John Kennedy" itself is an instance of the value type "name". If Z is a proper noun, we may treat X as a *relationship* between Y and Z . If Z is not a proper noun, we can say that Z is an instance of a *pure* value type, that is, it does not represent an entity. Therefore, we may treat X as an attribute of Y .

EXAMPLE D.

English statement: The color of the desk is blue.

Analysis: Since "blue" is not a proper noun, we may infer that "color" is an "attribute" of "desk" entities.

ER diagram: The corresponding ER diagram is shown in Figure 6.

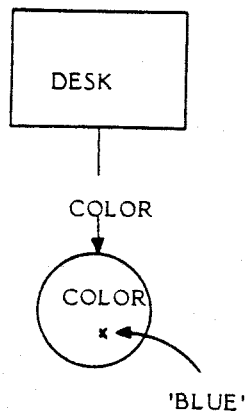

Fig. 6. An ER diagram for Example D.

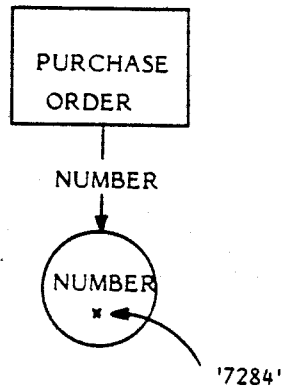

Fig. 7. An ER diagram for Example E.

EXAMPLE E.

English statement: The number of the purchase order is 7284.

Analysis: Since "7284" is a numeric and is not a proper noun, we may infer that "number" is an attribute of "purchase-order" entities.

ER diagram: The corresponding ER diagram is shown in Figure 7

EXAMPLE F.

English statement: The father of James Smith is Robert Smith.

Analysis: Since both "James Smith" and "Robert Smith" are proper nouns, we can say that both of them refer to entities and that "father" is a *relationship* between these two entities. If we assume that both "James Smith" and "Robert Smith" refer to entities of the "person" entity types, we may say that "father" is a relationship between "person" entities.

ER diagram: The corresponding ER diagram is shown in Figure 8.

RULE 8. The *objects* of algebraic or numeric operations can be considered as *attributes*.

EXAMPLE G.

English statement: The average salary is \$20,000, and the maximum credit limit is \$500.

Analysis: Since both "average" and "maximum" are algebraic operations, we may infer that "salary" and "credit limit" are attributes (of implicit employee entities). Actually, this rule can be derived from Rule 7 if we add the missing components to the original sentence. For example, the sentence "the average salary is \$20,000" can be changed into its equivalent "the average salary of employees is \$20,000". Using Rule 7, we can derive that "salary" is an attribute of "employee" entities.

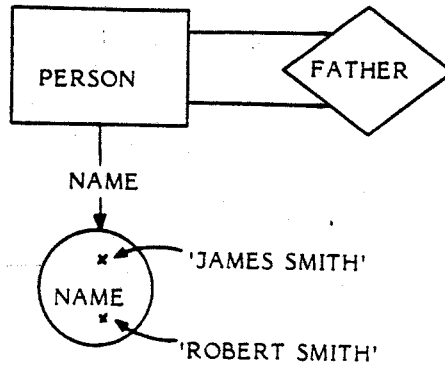

Fig. 8. An ER diagram for Example F.

RULE 9. A *gerund* in English corresponds to a *relationship-converted entity type* in ER diagrams.

EXPLANATION. In Rule 2, a transitive verb corresponds to a relationship type. In Rule #1, a noun corresponds to an entity type. Since a gerund is a noun converted from a verb, we may say that it corresponds to an entity type converted from a relationship type.

EXAMPLE H.

English statement: Products are shipped to customers, and the shipping is performed by clerks.

Analysis: Both "product" and "customer" are entity types, and "shipped to" is a relationship type between them. The verb "ship" is then converted to a gerund "shipping" in order to become the subject of the second clause. In other words, the relationship type "shipped to" has been converted into the entity type "shipping." The relationship type "performed by" is defined on the entity type "shipping" and the entity type "clerk."

ER diagrams: Figure 9 is the ER diagram representing the first clause: "Products are shipped to customers." Figure 10 is the ER diagram representing the entire sentence. Note that we use a special symbol, a rectangular-shaped box



Fig. 9. An ER diagram for Example H (part 1).

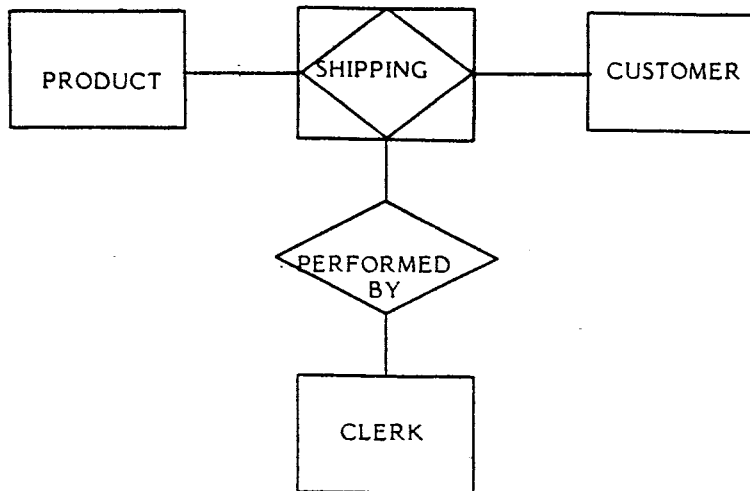

Fig. 10. An ER diagram for Example H (part 2).

on top of a diamond-shaped box, to represent a relationship-converted entity type.

RULE 10. A *clause* in English is a high-level entity type abstracted from a group of interconnected low-level entity and relationship types in ER diagrams.

EXPLANATION. The clause is a major building block in English. A clause can be used to build another clause. On the other hand, a clause may be decomposed further into subclauses.

EXAMPLE I.

English statement: The managers decide which machine is assigned to which employee.

Analysis: "Which machine is assigned to which employee" is a noun clause used as the object of the verb "decide." Inside this clause, "machine" and "employee" are entity types, and "assigned to" is a relationship type defined between "employee" and "machine." We could view the entire clause as an equivalent to a high-level entity called *assignment*.

ER diagram: Figure 11 is the corresponding ER diagram. Note that the clause is represented by a high-level rectangular-shaped box, which encloses a group of interconnected low-level entity and relationship types.

RULE 11. A *sentence* in English corresponds to one or more entity types connected by a relationship type, in which each entity type can be decomposed (recursively) into low-level entity types interconnected by relationship types.

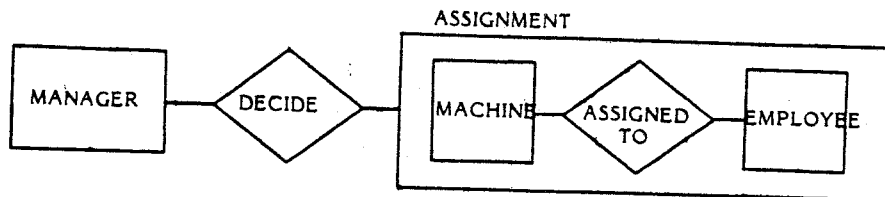

Fig. 11. An ER diagram for Example I.

EXPLANATION. Each sentence has one or more nouns, which correspond to entity types. In addition, each sentence has one verb, which corresponds to a relationship type. Since a sentence may be decomposed into clauses, which in turn may be decomposed into subclauses, the corresponding entity types may be decomposed (recursively) into low-level entity types interconnected by a relationship type.

Certainly, these are the basic rules. We expect that more rules will be developed in the future.

3. AN EXAMPLE

In this section, we will describe an example of translating a short English description of information requirements into an ER diagram. The example, which was a revision of a case study originally proposed in [3], is taken from Teorey and Fry's paper [16]. It is a description of the information requirements of an information system for labor and employee management in a manufacturing firm. Teorey and Fry [16] converted this description into an ER diagram, but they did not explain in detail how the ER diagram was derived. In this section we apply the rules described in the previous section to the translation of the English description into an ER diagram, and then compare our result with Teorey and Fry's.

3.1. ENGLISH DESCRIPTION OF INFORMATION REQUIREMENTS

As mentioned, a manufacturing firm wishes to develop a computer-based information system for labor and employee management. The following is the English description of the information requirements of the proposed information system:

The company has 50 plants located in 40 states and approximately 100,000 employees. Each plant is divided into departments and further subdivided into work stations. There are 100 departments and 500 work stations in the company. In each department there is an on-line time clock at which employees report their arrival and departure. A work task is associated with one

of 20 different job types. Each of the job types can be performed at each of the plants. During a given day an employee may perform more than one work task, each associated with a different job type, and each can be performed at a different work station. Each work station has an on-line data entry device at which an employee reports activity on a work task. There are five worker unions represented in the company, and every employee belongs to exactly one union. Although the size of the company remains stable, about 20 percent of the employees leave each year and are replaced by new personnel. ([16, p. 191], with minor modifications.)

3.2. TRANSLATION

Figure 12 is the ER diagram derived by Teorey and Fry from the above English description, but there are several unanswered questions. For example, how can anyone (without previous experience) derive Figure 12 from the English description given? Is Figure 12 the only representation of this English description? In the following, we are going to translate the English description into an ER diagram using the rules described in the previous section. We will then compare our result with Teorey's result. Although we do not have clear-cut answers to the questions raised above, we do believe that the following exercise will stimulate more research into this area so that a more rigorous methodology will be developed in the future.

In the following, we will analyze the English description one sentence at a time.

STATEMENT 1. The company has 50 plants located in 40 states and approximately 100,000 employees.

ANALYSIS AND TRANSLATION. This sentence can be decomposed into three sentences (clauses): (1) the company has 50 plants; (2) the 50 plants are located in 40 states; (3) the company has approximately 100,000 employees. Applying Rules 1 and 2, we get the ER diagram in Figure 13. Although the verb "has" is used in the original sentence, we use "HAS-1" and "HAS-2" in Figure 13 in order to make each relationship type name unique.

STATEMENT 2. Each plant is divided into departments and further subdivided into work stations.

ANALYSIS AND TRANSLATION. Applying Rules 1 and 2, we get the ER diagram in Figure 14.

STATEMENT 3. There are 100 departments and 500 work stations in the company.

ANALYSIS AND TRANSLATION. Applying Rule 5, we have the equivalent sentence: "The company has 100 departments and 500 work stations." However, this sentence has no new information on entity types or relationship types, and it contains only supplemental information to the previous two statements.

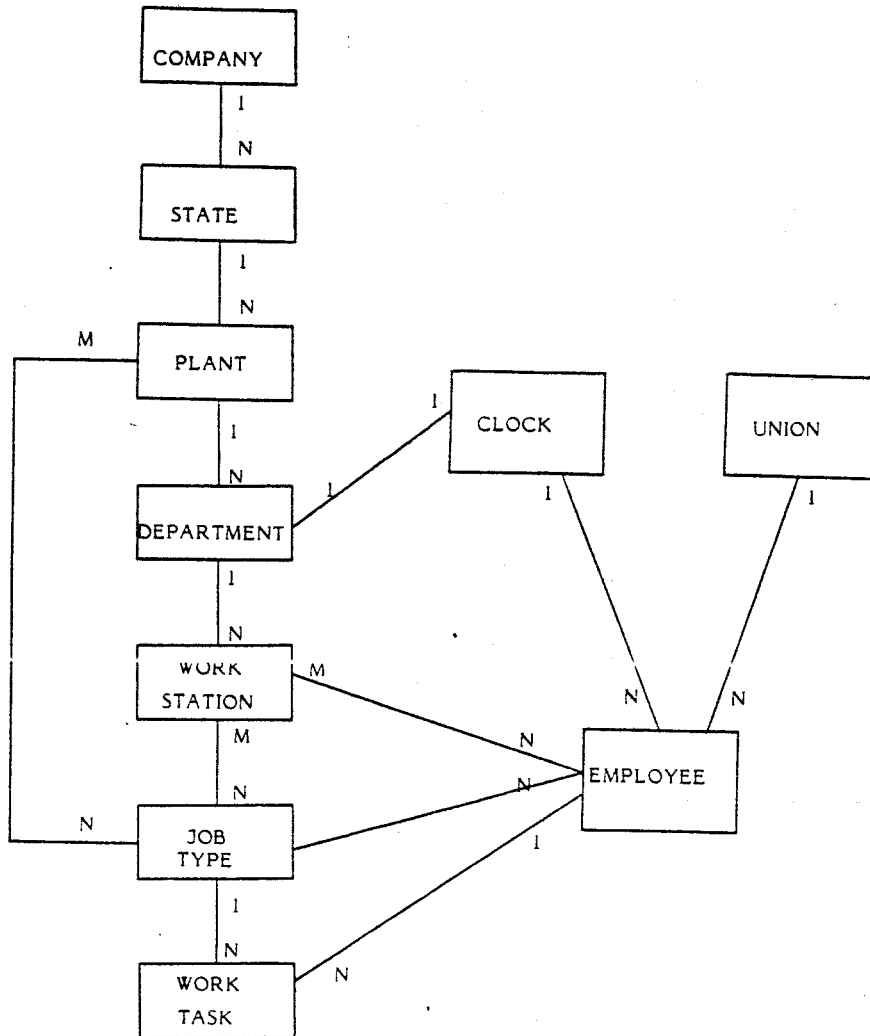

Fig. 12. The ER diagram taken from Teorey and Fry's paper [16, p. 193], with minor modifications.

For example, we now know the average value of M in Figure 14 is 2 (100 departments divided by 50 plants), and the average value of N in Figure 14 is 5 (500 work stations divided by 100 departments). This information is useful in the design of physical data structures but is not essential for the conceptualization of ER diagrams.

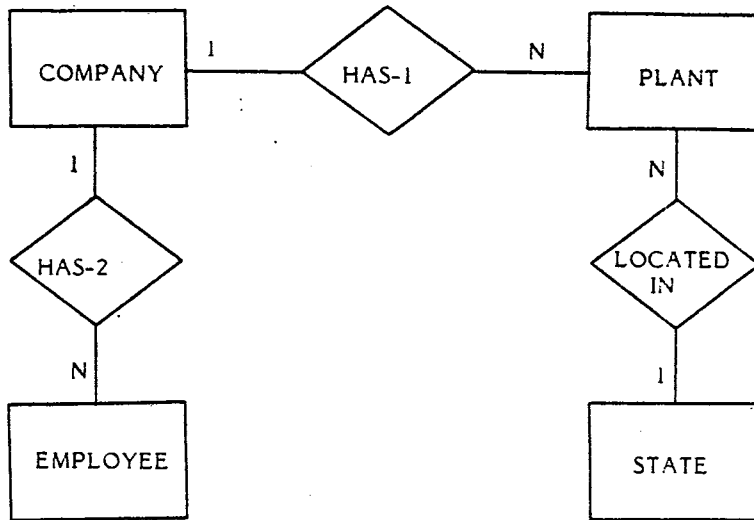

Fig. 13. An ER diagram for Statement 1.

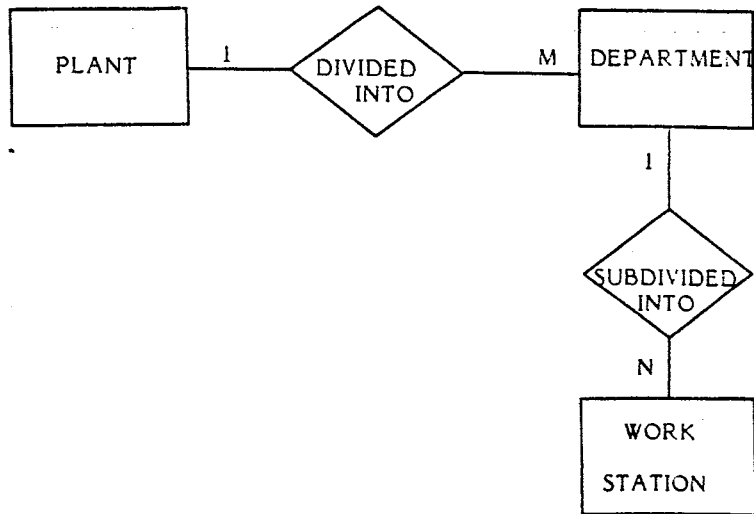

Fig. 14. An ER diagram for Statement 2.

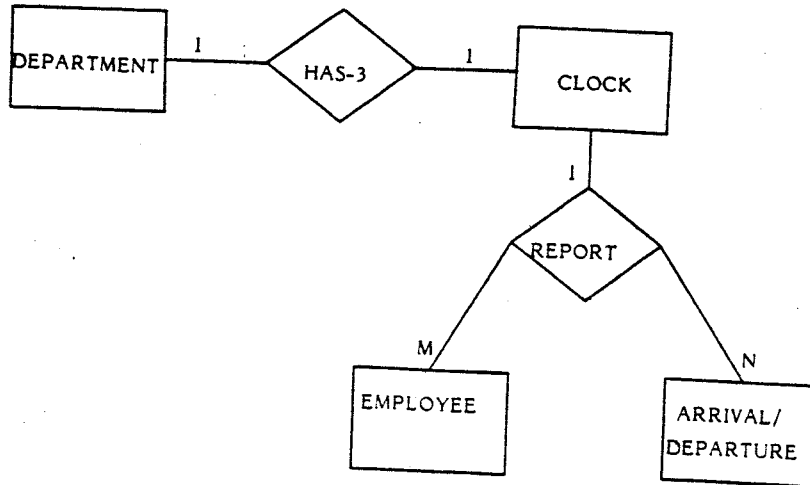

Fig. 15. An ER diagram for Statement 4.

STATEMENT 4. In each department there is an on-line time clock at which employees report their arrival and departure.

ANALYSIS AND TRANSLATION. Strictly speaking, this statement is concerned with how certain data are collected, and therefore is irrelevant to the construction of the ER diagram representing the database. However, for practice we will analyze this statement and derive the corresponding ER diagram.

This statement indicates that the relationship between "department" entities and "clock" entities is one-to-one. In addition, "employee," "clock," and "arrival/departure" are entities involved in a "report" relationship. The corresponding ER diagram is shown in Figure 15.

STATEMENT 5. A work task is associated with one of 20 different job types.

ANALYSIS AND TRANSLATION. This indicates that the relationship between "job type" entities and "work task" entities is one-to-many. The corresponding ER diagram is shown in Figure 16.



Fig. 16. An ER diagram for Statement 5.



Fig. 17. An ER diagram for Statement 6.

STATEMENT 6. Each of these job types can be performed at each of the plants.

ANALYSIS AND TRANSLATION. This indicates that the relationship between "job type" entities and "plant" entities is many-to-many. The corresponding ER diagram is shown in Figure 17.

STATEMENT 7. During a given day an employee may perform more than one work task, each associated with a different job type, and each can be performed at a different work station.

ANALYSIS AND TRANSLATION. This indicates that the relationship between "employee" entities and "work task" entities is one-to-many. Also, the relationship between "work task" entities and "job type" entities is many-to-one. It also implies that the relationship between "employee" entities and "work station" entities is many-to-many. The corresponding ER diagram is shown in Figure 18.

STATEMENT 8. Each work station has an on-line data entry device at which an employee reports activity on a work task.

ANALYSIS AND TRANSLATION. Similarly to Statement 4, this statement is concerned with data collection and is irrelevant to the construction of the ER diagram representing the database. For the benefit of those interested in the correspondence between ER diagrams and English statements, we perform the following analysis.

The relationship between "work station" entities and "(on-line) data entry device" entities is one-to-one. In addition, "employee," "work task activities," and "data entry device" are involved in a "report-2" relationship (The name "report-2" is used to distinguish it from the "report" relationship in Figure 15). The corresponding ER diagram is shown in Figure 19.

STATEMENT 9. There are five worker unions represented in the company, and every employee belongs to exactly one union.

ANALYSIS AND TRANSLATION. The relationship between "company" entities and "(worker) union" entities is one-to-many. In addition, the relationship between "employee" entities and "union" entities is many-to-one. The corresponding ER diagram is shown in Figure 20.

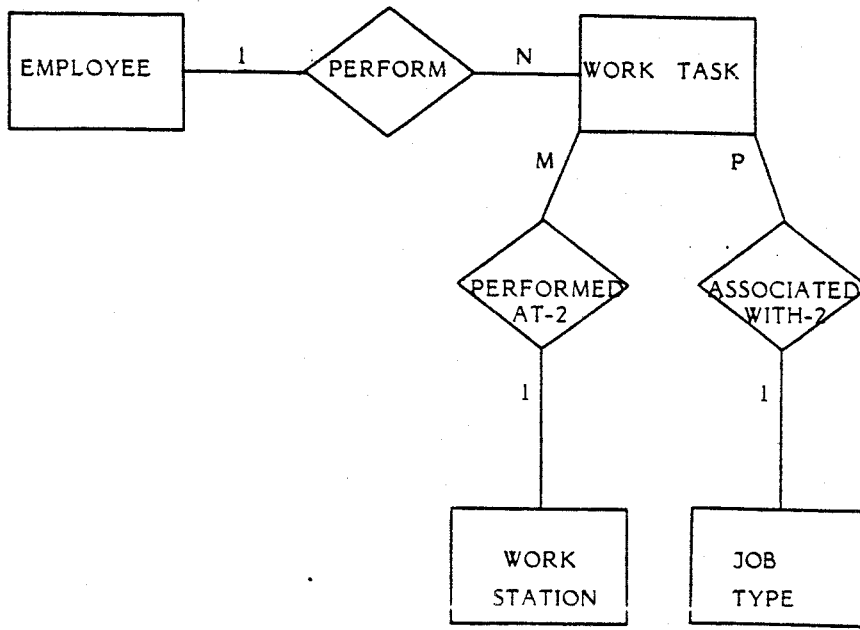

Fig. 18. An ER diagram for Statement 7.

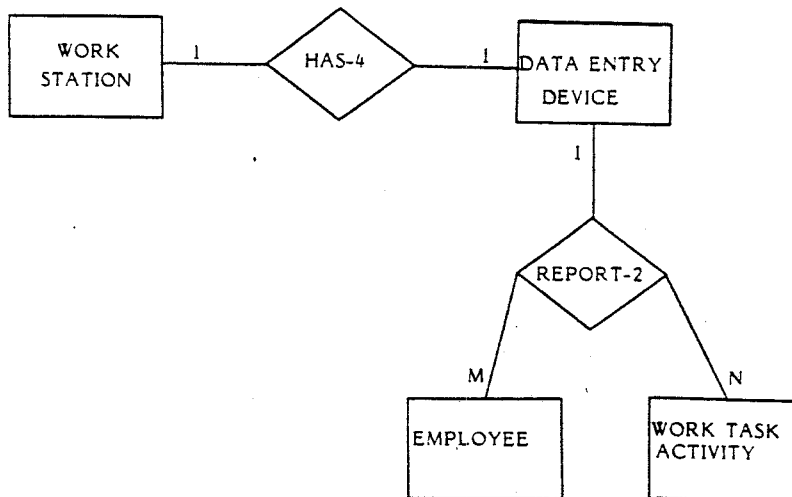

Fig. 19. An ER diagram for Statement 8.

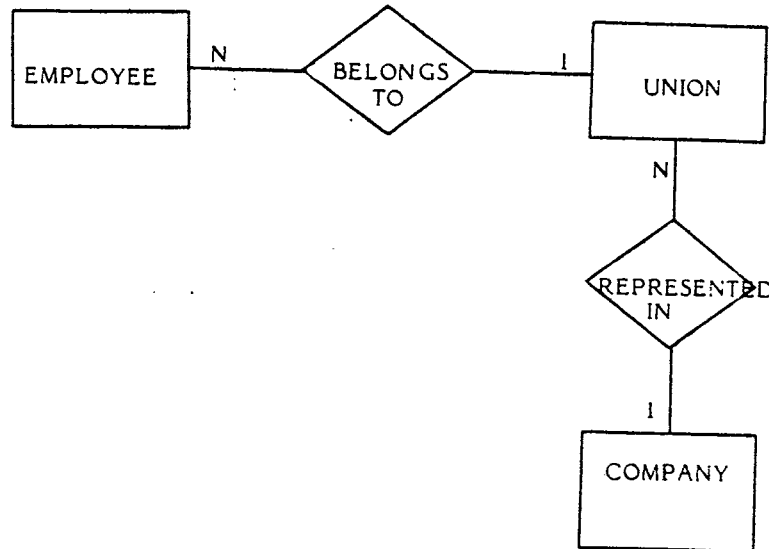

Fig. 20. An ER diagram for Statement 9.

STATEMENT 10. Although the size of the company remains stable, about 20 percent of the employees leave each year and are replaced by new personnel.

ANALYSIS AND TRANSLATION. The relationship between "employee" entities and "company" entities has been shown in Figure 13. This statement gives only the frequency of changing (updating) the actual relationship instances between "company" entities and "employee" entities; it does not provide information on new entity or relationship types.

In the preceding, we have analyzed each statement and derived a corresponding ER diagram. These individual diagrams can be merged to form an overall ER diagram. Figure 21 is such a diagram, formed by merging Figures 13 to 20 (without Figures 15 and 19). Since there is no attribute for any relationship in Figure 21, we may use a simple convention in drawing ER diagrams (using straight lines instead of diamond-shaped boxes to represent relationship types and no explicit names for relationship types). Figure 22 is the resulting version of the diagram. Also, since we are modeling the information requirements for a specific company only, we can delete the "company" entity type, and then Figure 23 becomes the final ER diagram.

3.3. COMPARISON OF RESULTS

What are the differences between the ER diagram derived from the translation rules and the ER diagram derived by Teorey and Fry? Comparing Figure

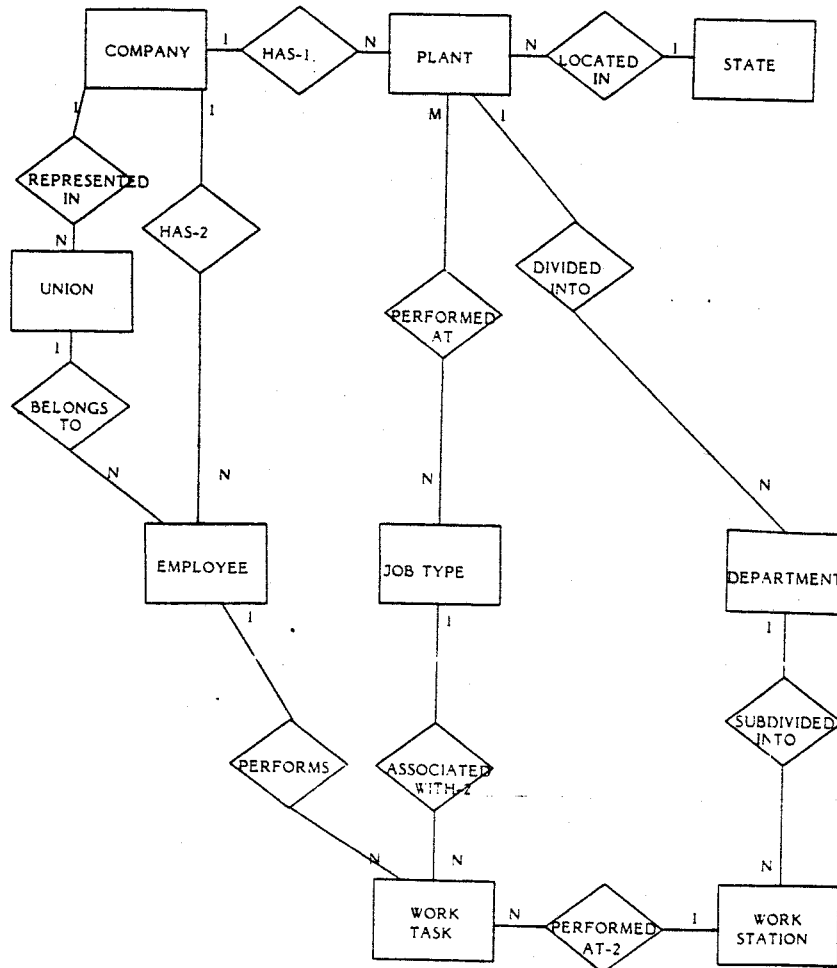

Fig. 21. An overall ER diagram.

23 with Figure 12, we can see that in Figure 12, there are two more entity types (**COMPANY** and **CLOCK**)¹ and three more relationship types (**EMPLOYEE-WORK-STATION**, **EMPLOYEE-JOB-TYPE**, and **WORK-STATION-JOB-TYPE**). In addition, the relationship type **WORK-STATION-WORK-TASK** is missing in Figure 23. Are these differences significant or superficial? Which diagram is more faithful to the original English description? In the following, we will attempt to address these questions.

¹In the figures, we use capital letters (instead of quotation marks) to denote entity or relationship type names.

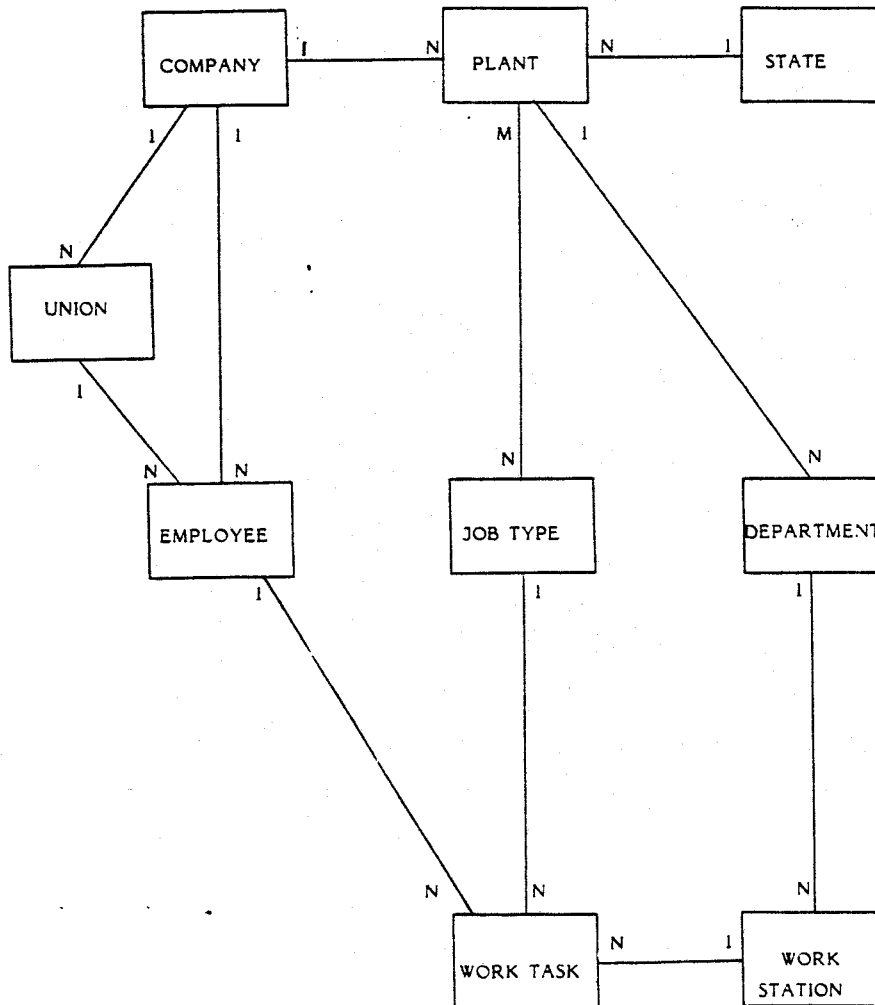

Fig. 22. A revised ER diagram corresponding to Figure 21.

Let us first examine the extra entity types. In Figure 23, we do not have the **COMPANY** entity type, since we said that we were modeling a specific company. If we were to accept **COMPANY** as an entity type, we probably should have two additional relationship types as shown in Figure 22: **COMPANY-EMPLOYEE** and **COMPANY-PLANT**. In addition, the relationship type **COMPANY-STATE** in Figure 12 is not directly derivable from the original English description. The **CLOCK** entity type in Figure 12 is not included in Figure 23, since we said that it was

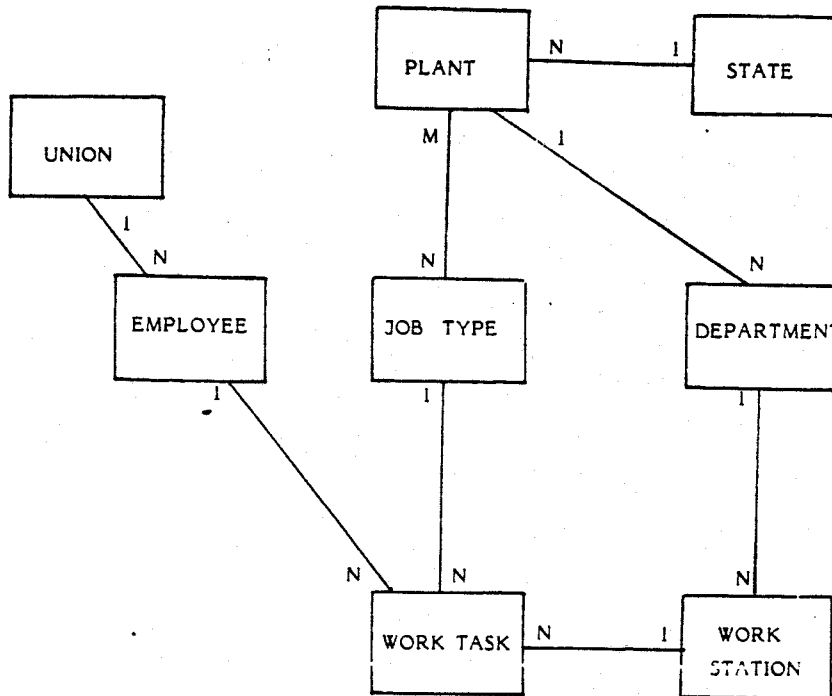

Fig. 23. The final ER diagram.

related to the data collection activity and was not relevant to the construction of the database itself. If we were to include the **CLOCK** entity type, we should also include the **DATA-ENTRY-DEVICE** (see Figure 19) for the sake of consistency.

Now, let us examine the extra relationship types. We think that these extra relationship types may be derivable from the existing relationship types in Figure 23. For example, the **WORK-STATION-JOB-TYPE** relationship in Figure 12 may be inferred by combining the two relationship types in Figure 23: **JOB-TYPE-WORK-TASK** and **WORK-TASK-WORK-STATION**. The extra relationship **EMPLOYEE-JOB-TYPE** may be derived by combining the two relationship types **EMPLOYEE-WORK-TASK** and **WORK-TASK-JOB-TYPE**. Similarly, we can construct the extra relationship type **EMPLOYEE-WORK-STATION** through other relationship types. Therefore, the extra relationship types in Figure 12 do not contain significant extra information, and they are derivable from the existing relationship types in Figure 23.

Finally, let us discuss the relationship type **WORK-TASK-WORK-STATION**, which is missing in Figure 12. It seems that this relationship type cannot be derived completely from other relationship types, since we cannot decide

whether this relationship type is one-to-one, one-to-many, or many-to-many. We think that a reason should be given why this relationship is deleted in Figure 12.

In conclusion, Figure 23 and Figure 12 are very similar. However, Figure 23 is a more faithful representation of the original English description of the information requirements. It seems that additional information, which is based on the database designer's own knowledge of the system, was incorporated into the construction of the ER diagram in Figure 12. However, this additional information was not documented, and it is difficult for any person to derive Figure 12 based solely on the original English descriptions. It is not our intention to claim that Figure 23 is better than Figure 12. What we try to do here is to demonstrate that by systematically applying the translation rules proposed in Section 2, a more faithful representation can be obtained. We believe that by following the translation rules we can rely less on the database designers' intuition and more on structured methods. We hope that these translation rules can stimulate more research on a rigorous and comprehensive logical database design methodology.

4. CONCLUSION

In this paper, we have proposed eleven basic rules for translation between English sentences and ER diagrams. These translation rules can be used in the conversion of an English language description of information requirements into ER diagrams. Using an example, we have demonstrated that an ER diagram more faithful to the original description can be derived by systematically applying the translation rules instead of relying solely on database designers' intuition.

Certainly, the rules provided in this paper are not complete and may have exceptions. However, we hope this paper will stimulate more research in this area so that a set of more complete and accurate rules may be defined in the near future and that a more rigorous methodology for information requirements analysis and logical database design can be developed.

The author would like to thank Dennis Perry and Ilchoo Chung for their contribution of ideas for the translation rules.

REFERENCES

1. C. Batini. Top-down design of entity-relationship models, in *Entity-Relationship Approach to Systems Analysis and Design* (P. Chen, Ed.). North-Holland, Amsterdam, 1980.
2. R. L. Benneworth et al., The implementation of GERM, an entity-relationship data base

- management system, in *Proceedings of the Seventh Very Large Data Base Conference*, Cannes, France, Sept. 1981.
3. J. Bubenko, S. Berlid, E. Lindencrona-Ohlin, and S. A. Nachmens, From information requirements to DBTG data structures, in *Proceedings of the ACM SIGMOD International Conference on Management of Data*, 1977.
 4. P. P. Chen, The entity-relationship model: Toward a unified view of data, *ACM Trans. Database Systems* 1, No. 1 (Mar. 1976).
 5. P. P. Chen, The entity-relationship model: A basis for the enterprise view of data, in *Proceedings of the 1977 National Computer Conference*, Dallas, June 1977.
 6. P. P. Chen, A preliminary framework for entity-relationship model, in: *Entity-Relationship Approach to Information Modeling and Analysis* (P. Chen, Ed.), ER Institute, P.O. Box 617, Saugus, CA 91350, 1981.
 7. T. C. Chiang and R. F. Bergeron, A data base management system with an E-R conceptual model," in *Entity-Relationship Approach to Systems Analysis and Design* (P. Chen, Ed.), North-Holland, Amsterdam, 1980.
 8. R. Elmasri and G. Wiederhold, GORDAS: A formal high-level query language for the entity-relationship model," in *Entity-Relationship Approach to Information Modeling and Analysis* (P. Chen, Ed.), ER Institute, P.O. Box 617, Saugus, CA 91350, 1981.
 9. E. Y. Lien, The design of entity-relationship distributed data base systems, in *Proceedings of the 3rd IEEE Computer Society Compsac Conference*, Chicago, 1978.
 10. D. Lee and R. Gerritsen, A hybrid entity-relationship model. Working Paper, Wharton School, Univ. of Pennsylvania, Philadelphia, 1977.
 11. E. L. Lusk, R. A. Overbeek, and B. Parrello, The design of IMS databases from entity-relationship model, in *Proceedings of the 1980 ACM SIGMOD International Conference on Management of Data*, Los Angeles, 1980.
 12. P. Ng, Formal definitions of the entity-relationship model, *IEEE Trans. Software Engrg.*, 1980.
 13. H. Sakai, On the optimization of the entity-relationship model, in *Proceedings of the 3rd USA-Japan Computer Conference*, AFIPS Press, N.J., 1978.
 14. C. S. dos Santos, E. J. Neuhold, and A. L. Furtado, A data type approach to the entity-relationship model, in *Entity-Relationship Approach to Systems Analysis and Design* (P. Chen, Ed.), North-Holland, Amsterdam, 1980.
 15. G. Schiffner and P. Scheuermann, Multiple view and abstractions with an extended entity-relationship model, *J. Comput. Languages* 4:139-154 (1980).
 16. T. J. Teorey and J. P. Fry, The logical record access approach to database design, *ACM Comput. Surveys* 12:2 (June 1980).
 17. J. D. Ullman, *Principles of Database Systems*, Computer Science Press, 1980.
 18. N. Webre, An extended entity-relationship model and its use on a defense project, in *Entity-Relationship Approach to Information Modeling and Analysis* (P. Chen, Ed.), ER Institute, P.O. Box 617, Saugus, CA 91350, 1981.

Note: Entity-Relationship Approach to Information Modeling and Analysis (P. Chen, Editor) has been republished by North-Holland Publishing Company, 1983.